

Facsimile

Quick Reference Guide

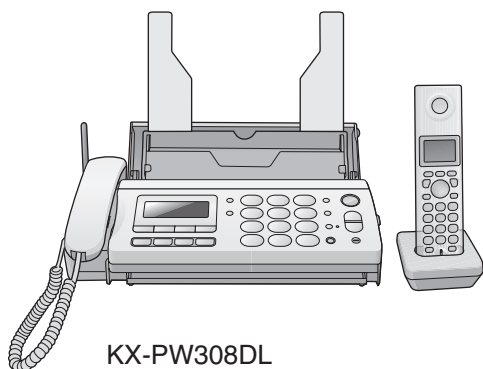

KX-PW308DL

Model No. **KX-PW308DL**
KX-PW308DW

Main unit: KX-PW308
 Portable handset: KX-FKN526

Thank you for purchasing a Panasonic facsimile.

Table of Contents

Finding the controls	2
Installations and connections	4
Setting the date and time.....	7
Setting your facsimile telephone number	7
Setting your logo	8
Character input and command key table	9
Voice guide.....	10
Automatic dialing on the main unit	11
Automatic dialing on the portable handset (KX-FKN526)	13
Intercom	14
Sending faxes	15
Receiving faxes	16
Operating the built-in answering device	17
Call block	19
Specifications	Back cover

- This guide explains some basic features and operations, but not all of them.
For further details, see the Japanese operating instructions.
- This product is designed for use in Japan.
Panasonic cannot provide service for this product if used outside Japan.
- Any details given in this guide are subject to change without notice.

This unit is equipped with the voice guide features. (Japanese only)
For details about voice guide, please see page 10.

Finding the controls

Main unit

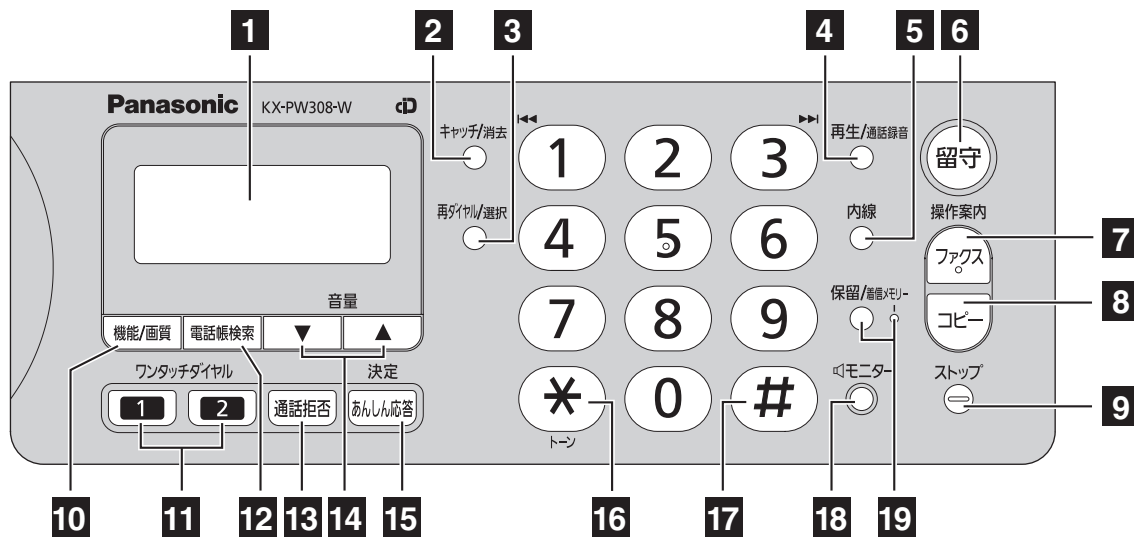

1 Liquid crystal display

2 Flash button (For call waiting service users.)
Erase button

3 Redial button redials the phone numbers in the redial list. The last 10 phone numbers dialed are stored in memory.

Select button

4 Playback button plays back recorded messages.

Record button records a telephone conversation.

5 Intercom button

6 Auto Answer button & indicator

—light on: answering device activated.

—light off: used as a regular telephone.

7 Fax button starts faxing.

8 Copy button starts copying.

9 Stop button

10 Function button initiates programming.

Resolution button selects the resolution when faxing or copying.

11 One-touch Dial buttons

12 Phonebook button

13 Block button for the undesired call

14 Volume buttons adjust the volume.

Search buttons

15 Secure button

While the unit is ringing, press this button. The unit announces a message to the caller. The message is announced in Japanese and means “This unit is currently set to Caller Verifying mode. Could you please speak out your name?”.

■ To talk to the caller, lift the handset.

■ To hang up, press **(*)**.

Set button stores a parameter.

16 Tone button switches to tone dialing.

17 Sharp button

18 Monitor button

19 Hold button

Call Memory button starts a search in the Number Display (Caller ID) log.



Call Memory indicator lights when a call was missed.





(For Number Display service users.)

Finding the controls



Portable handset (KX-FKN526)

How to use key

-  電話帳 ● To use the phonebook.
-  再呼び ● To redial the phone numbers in the redial list. The last 10 phone numbers dialed are stored in memory.
-  音量 ● To adjust the volume.

-  外線 ● To make/answer calls.
-  切 ● To end a call.
● To end or exit from editing or other operations.
-  保留 ● To put a call on hold.
着信メモリー ● To start a search in the Number Display log. (For Number Display service users.)
-  内線 ● To page the main unit and/or portable handset(s).
文字切替 ● To change the character input mode.

Dial buttons

-  * トーン Tone button
● To switch to tone dialing.
-  # 鋭 Key lock button
● To lock the portable handset so that no calls or settings can be made. To turn key lock on, press this button for about 3 seconds until a single beep is heard.
● To turn key lock off, press this button for about 3 seconds until a single beep is heard.

Earpiece

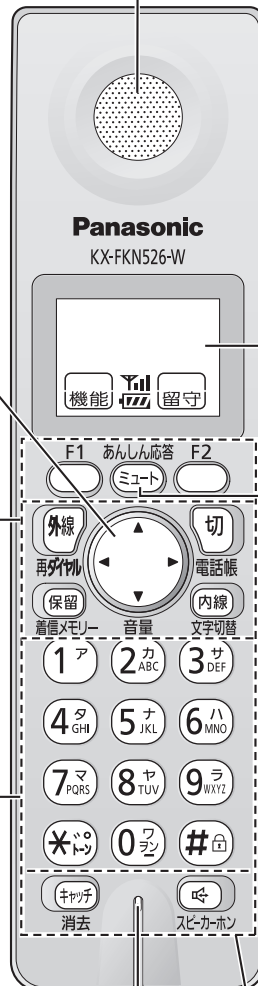



Microphone

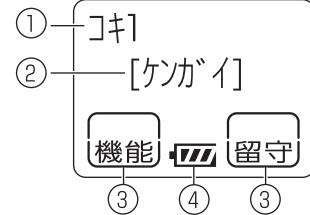

(Do not cover the microphone while talking.)

Liquid crystal display



- ① Portable handset number (and name)
- ② No link to the main unit
- ③ Function menu that is controlled by  or 
- ④ Battery strength



How to use buttons

 and  buttons refer to the function displayed on the bottom of the display. They function differently depending on the mode.

あんしん応答
ミュート

Secure button

- While the portable handset is ringing, press this button. The portable handset announces a message to the caller. The message is announced in Japanese and means "This unit is currently set to Caller Verifying mode. Could you please speak out your name?".

- To talk to the caller, press .
- To hung up, press .

Mute button

- To mute your voice to the other party by pressing this button. (To release the mute, press this button again.)

キヤッチ
消去

- For call waiting service users.
- To clear letters/numbers.

スピーカホン

- To use the speakerphone.

Installations and connections

Installing the ink film

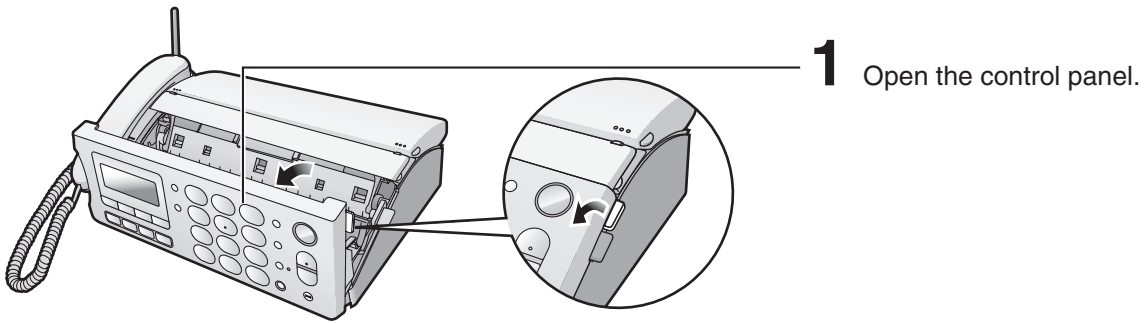

1 Open the control panel.

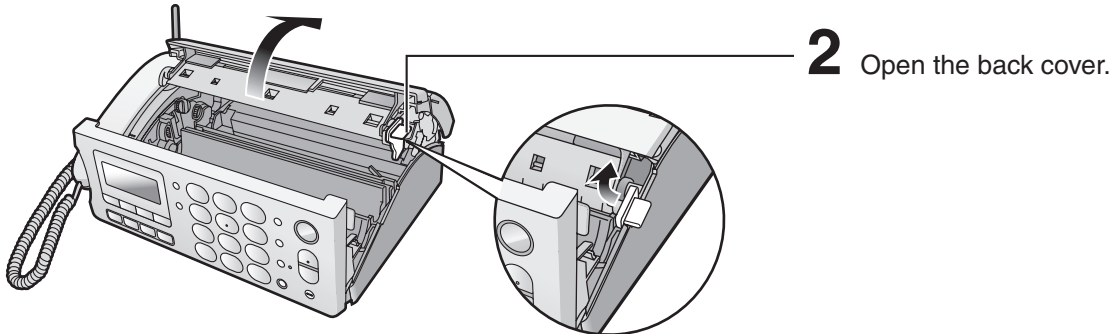

2 Open the back cover.

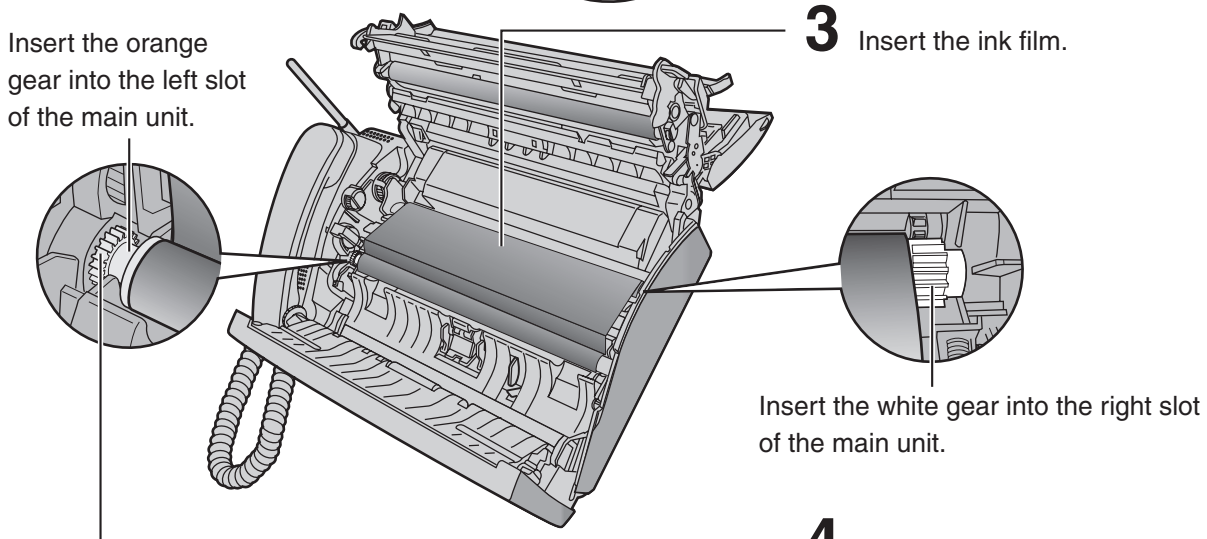

Insert the orange gear into the left slot of the main unit.

3 Insert the ink film.

Insert the white gear into the right slot of the main unit.

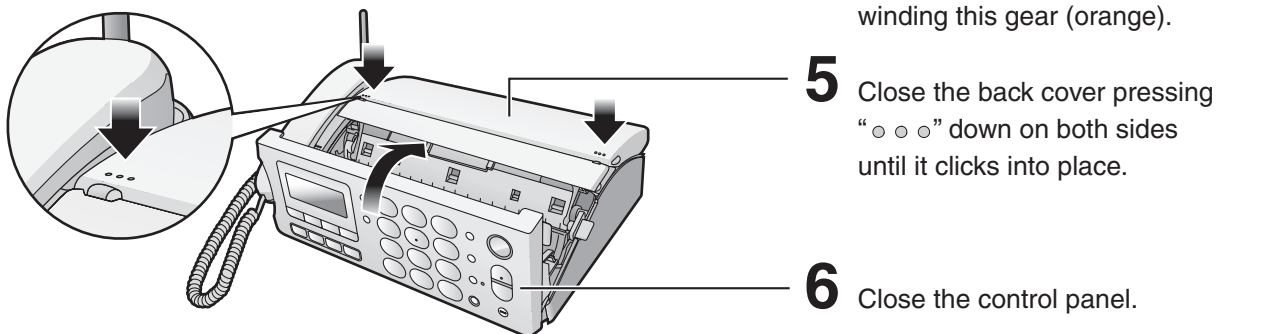

4 If the ink film is slack, tighten it by winding this gear (orange).

5 Close the back cover pressing “○○○” down on both sides until it clicks into place.

6 Close the control panel.

• When the unit runs out of ink film, the following message will be displayed.

フィルムカ* ナクナリマシタ コウカンシテクタ* サイ U23	←	フィルムカ* ナクナリマシタ ヒンバ:ン:KX-FAN190
------------------------------------	---	-----------------------------------

Install a new ink film.

Replacement ink film:	
KX-FAN190 (15 m)	¥714
KX-FAN190W (15 m X 2)	¥1,208
KX-FAN191 (15 m) (*1)	¥893
KX-FAN191W (15 m X 2) (*1)	¥1,523

*1 KX-FAN191/KX-FAN191W leaves a fainter print trail on the film than does the KX-FAN190/190W.

· As of August 2008. · Tax included.

Installations and connections

Installing recording paper (A4 size)

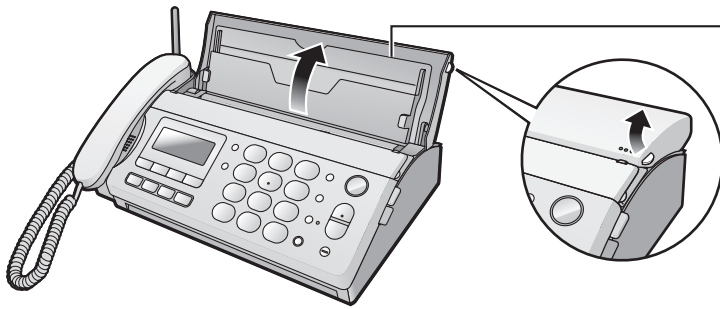

1 Open the recording paper tray.

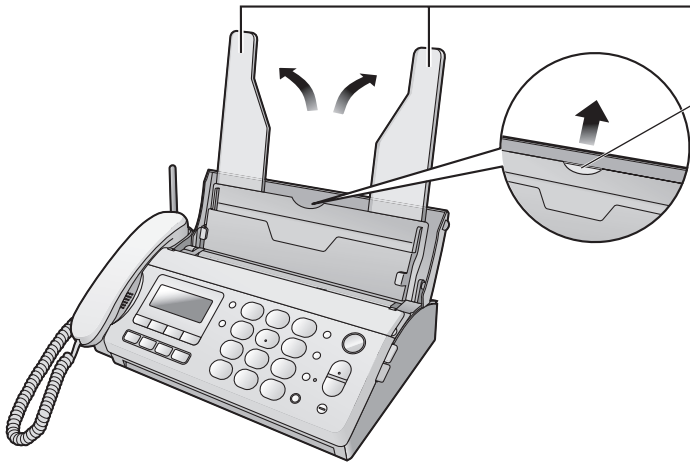

2 Set up the recording paper stands.

Pull out the front stand first.

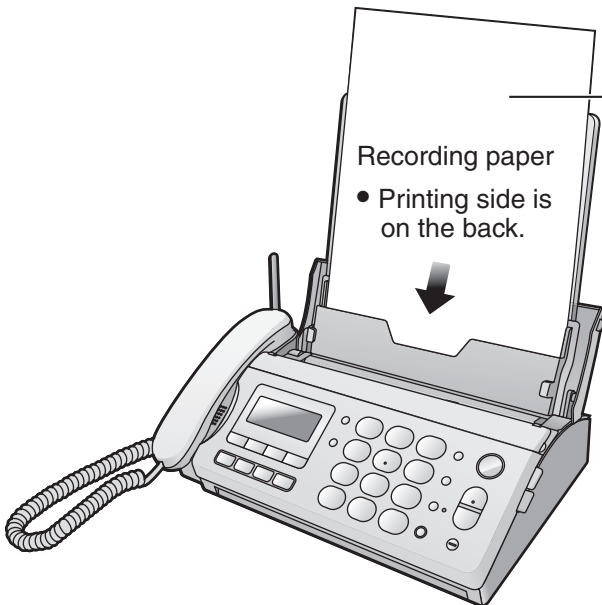

Recording paper
• Printing side is on the back.

3 Insert the recording paper into the recording paper tray. (Up to 15 sheets)

- Fan the stack of recording paper.

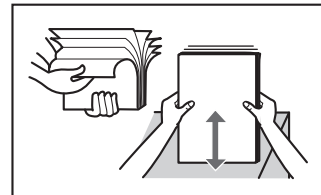

Folding the recording paper tray

① Remove the recording paper and fold the recording paper stands in.



② Close the recording paper tray.



Installations and connections

Connecting the main unit

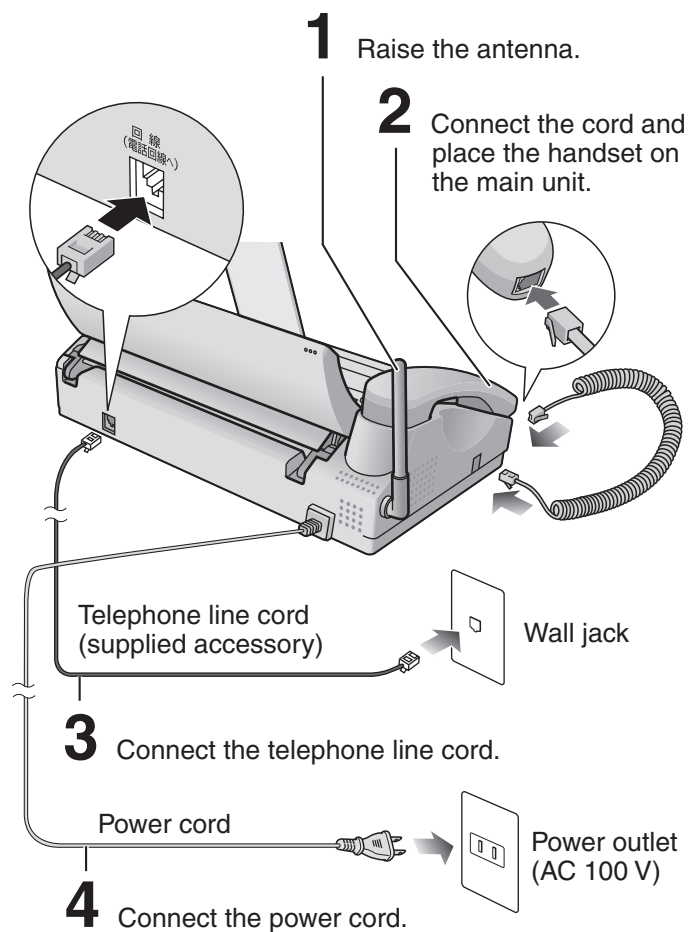

After the Power On...

- ① This unit will automatically select the dialing mode (Pulse/Tone).
- ② When the following is displayed, press
ストップ (Stop). エラシテ ケータイノセツテイ
[ケツテイ]オス

If you cannot make a call...

Set the dialing mode with the main unit.

1. Press 機能/画質 (Function/Resolution).
2. Press # 0 7 9.
3. Press 再ダイヤル/選択 (Search button) repeatedly until the desired setting is selected.

Example :

- | | |
|----------------------------------|---|
| カイセンシユハ ツ=ジトウ
[センタク]→[ケツテイ]オス | • プッシュ: Tone
20: Pulse (20 PPS)
10: Pulse (10 PPS)
ジトウ: Auto (Default) |
|----------------------------------|---|

4. Press 決定 あんしん応答 (Set).
5. Press ストップ (Stop).

Setting up the portable handset (KX-FKN526)

- 1 Press ☰ on the battery cover and slide the cover.

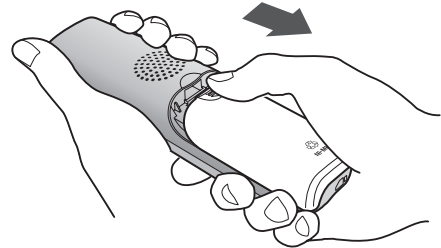

- 2 Insert the battery into the compartment and close the battery cover.

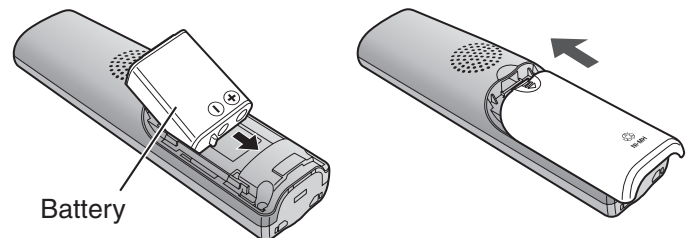

- 3 Connect the charger to the power outlet, then place the portable handset on the charger for about 10 hours.

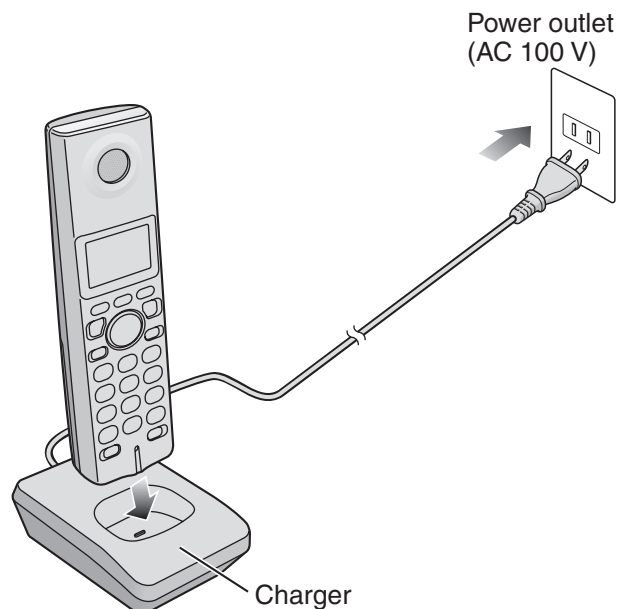

- After your Panasonic battery is fully charged, it will last up to about 5 hours of conversation.

Setting the date and time

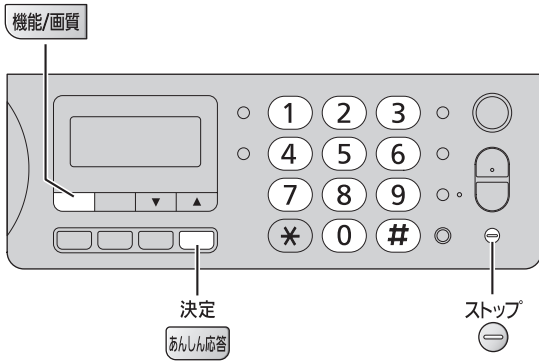

1 Press **機能/画質** (Function/Resolution).

キノ トウロク モード
[▼,▲]オス

2 Press **# 0 0 1**.

ヒツケ・ジ コクノ セツテイ
[ケツテイ]オス

3 Press **決定 あんしん応答** (Set).

Example :

2008年11月30日
15:00
Cursor

4 Enter the correct year/month/day.

Example: December 1, 2008

Press **2 0 0 8 1 2 0 1**.

2008年12月01日
15:00

5 Enter the correct hour/minute in a 24-hour clock entry.

Example: 15:45 (3:45 PM)

Press **1 5 4 5**.

2008年12月01日
15:45

6 Press **決定 あんしん応答** (Set).

トウロク シマシタ



ヒツケ・ジ コクノ セツテイ
[ケツテイ]オス

7 Press **ストップ** (Stop).

Example :

12月 1日 15:45
ヨウケン ロクオン 0ケン

Setting your facsimile telephone number

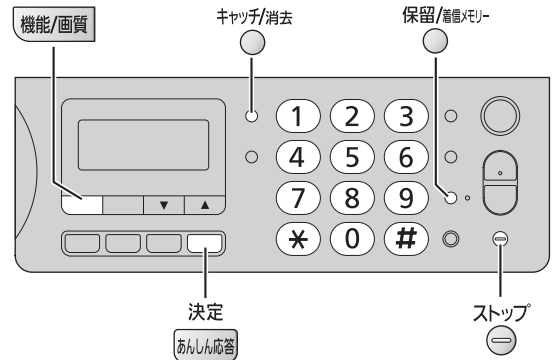

1 Press **機能/画質** (Function/Resolution).

キノ トウロク モード
[▼,▲]オス

2 Press **# 0 0 4**.

アナタノデ ソウバノゴウ
[ケツテイ]オス

3 Press **決定 あんしん応答** (Set).

TEL?

4 Enter your facsimile telephone number, up to 20 digits.

Example: +098 7654..

TEL?
+098 7654..

- To correct a mistake, press **キャッチ/消去** (Flash/Erase).
- The **保留/着信メモリー** button replaces the digit with a space.
- The **トーン** button replaces the digit with "+".

5 Press **決定 あんしん応答** (Set).

トウロク シマシタ



アナタノデ ソウバノゴウ
[ケツテイ]オス

6 Press **ストップ** (Stop).

Example :

12月 1日 15:45
ヨウケン ロクオン 0ケン

Setting your logo

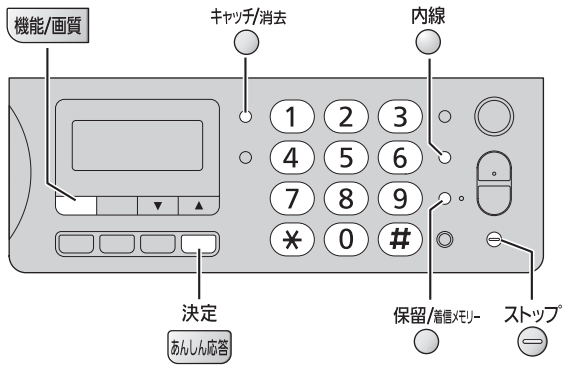

1 Press **機能/画質** (Function/Resolution).

キノ トウロク モード
[▼,▲]オス

2 Press **# 0 0 2**.

アナタノナマイ
[ケツテイ]オス

3 Press **決定 あんしん応答** (Set).

ナマイ? [カナ]
Cursor

4 Enter your logo, up to 30 characters, using the dial keypad.

- To enter English characters easily, press **内線** (Intercom) repeatedly and select "AB" (English and sign input mode).
- For details, see the table on page 9 for instructions.

Example: Micah

1. Press **6** once.

ナマイ? [AB]
M
Cursor

2. Press **4** six times.

ナマイ? [AB]
Mi

3. Press **2** six times.

ナマイ? [AB]
Mic

4. Press **#** to move the cursor to the next space, then press **2** four times.

ナマイ? [AB]
Mica

5. Press **4** five times.

ナマイ? [AB]
Micah

5 Press **決定 あんしん応答** (Set).

トウロク シマシタ
↓
アナタノナマイ
[ケツテイ]オス

6 Press **ストップ** (Stop).

Example :

12月 18 15:45
ヨウケン ロクオン 0ケン

Character input and command key table

Pressing the dial keys will select a character as shown below.

Character		Katakana	English and signs	Numbers
Display of the main unit and the portable handset		[カ]	[AB]	[12]
Dial key				
(Main unit) ①	(Portable handset KX-FKN526) ①	アイウエオ アイウエオ	@ . _ - & \$ ¥ % + = ~ ^	1
②	②	カキクケコ	A B C a b c	2
③	③	サシスセソ	D E F d e f	3
④	④	タチツテトツ	G H I g h i	4
⑤	⑤	ナニヌネノ	J K L j k l	5
⑥	⑥	ハヒフヘホ	M N O m n o	6
⑦	⑦	マミムメモ	P Q R S p q r s	7
⑧	⑧	ヤユヨヤユヨ	T U V t u v	8
⑨	⑨	ラリルレロ	W X Y Z w x y z	9
⑩	⑩	ワヨンー!?()	! ? / - * # , ; : · ' " () [] { } < > 「 」	0
✳	✳	ゝ っ っ っ	、 。	
Command keys		内線 ○ (Main unit), 内線 文字切替 (Portable handset)	Used to change the character input mode.	
		# (Main unit)	Used to move the cursor to the right.	
		⏪ (Portable handset)	Used to move the cursor to the left and right.	
		キャッチ/消去 ○ (Main unit), キャッチ 消去 (Portable handset)	Used to delete a character.	
		保留/通信メモリー ○ (Main unit), 保留 (Portable handset)	Used to insert a space.	

• The characters on the display are somewhat different from those shown in the character input and command key table.

Voice guide

Operation guide

The unit starts the following voice guidance in Japanese:

Operations	To cancel the operation guide (using the main unit)
Send a fax	機能/画質 → # 0 2 1 → 再ダイヤル/選択 (Select “ナシ”) → 決定 あんしん応答 → ストップ
Copy	機能/画質 → # 0 2 1 → 再ダイヤル/選択 (Select “ナシ”) → 決定 あんしん応答 → ストップ
Store phone numbers in the one-touch dialers	機能/画質 → # 1 6 7 → 再ダイヤル/選択 (Select “ナシ”) → 決定 あんしん応答 → ストップ
Make a call using the phonebook/redial/call memory	機能/画質 → # 1 6 7 → 再ダイヤル/選択 (Select “ナシ”) → 決定 あんしん応答 → ストップ
Change a ink film	機能/画質 → # 1 7 3 → 再ダイヤル/選択 (Select “ナシ”) → 決定 あんしん応答 → ストップ
Print fax documents from the main unit memory	機能/画質 → # 1 7 7 → 再ダイヤル/選択 (Select “ナシ”) → 決定 あんしん応答 → ストップ

Reading-out dial

The unit announces the number dialed in Japanese, when you make a call with the main unit.

• To cancel the reading-out dial



Automatic dialing on the main unit

Storing names and telephone numbers in the phonebook

To use the phonebook on the main unit, you need to transfer the stored phonebook of the portable handset to the main unit. (You cannot store directly in the phonebook on the main unit.)

Store names and telephone numbers in the portable handset phonebook before using this feature (see page 13).

Transferring the phonebook entries from the portable handset to the main unit

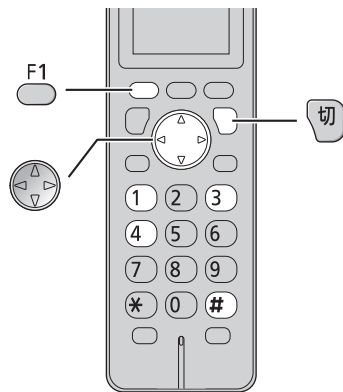

1 Press **F1**.

2 Press **# 1 4 3**.

テソウチョウ テソウ

3 Press **F1**.

テソウサキ=オヤキ
センタクハ[◀,▶]オス

4 Press **F1**.

5 ■ To transfer a stored phonebook entry individually

① Press **F1**.

② Press **Search button** repeatedly until the desired name is displayed.

③ Press **F1**.

• To transfer other names, repeat steps ② and ③.

④ After the “テソウ シマシタ” (Transfer complete) is displayed, press **Off**.

■ To transfer all of the stored phonebook entries

① Press **Search button** repeatedly to select “テソウチョウ=イッセイ” (Transfer all).

② Press **F1** twice.

③ After the “テソウ シマシタ” (Transfer complete) is displayed, press **Off**.

Making a voice call using the phonebook

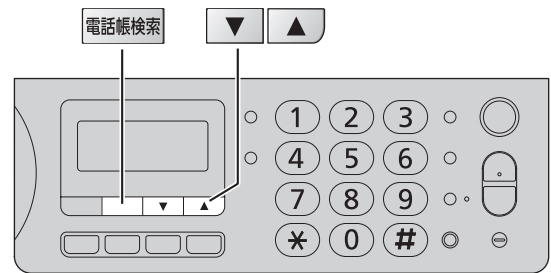

1 Press **電話帳検索** (Phonebook).

2 Press **Search button** repeatedly until the desired name is displayed.

3 Lift the handset.

Erasing a stored name and number in the phonebook

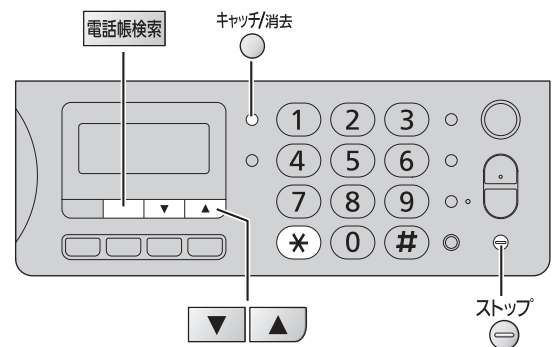

1 Press **電話帳検索** (Phonebook).

2 Press **Search button** repeatedly until the desired name is displayed.

3 Press **キャッチ/消去** (Erase).

4 Press *****.

5 Press **ストップ** (Stop).

Automatic dialing on the main unit

Storing telephone numbers in the one-touch dialers

You can store a telephone number in each one-touch dialer.

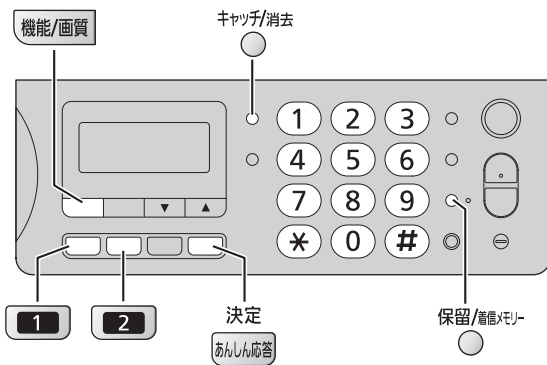

1 Press **機能/画質** (Function/Resolution).

キノウ トウロク モード
[▼,▲]オス

2 Press the one-touch dialer (**1** or **2**).

Example: one-touch dialer 1

One-touch dialer number

ワンタッチ1
トウロク ヲ カイシシマス



TEL?

3 Enter the telephone number, up to 24 digits.

- To correct a mistake, press **キャッチ/消去** (Flash/Erase).
- The **保留/着信メモリー** (Hold/Call memory) button replaces the digit with a space.

4 Press **決定** **あんしん応答** (Set).

Making a voice call using the one-touch dialer

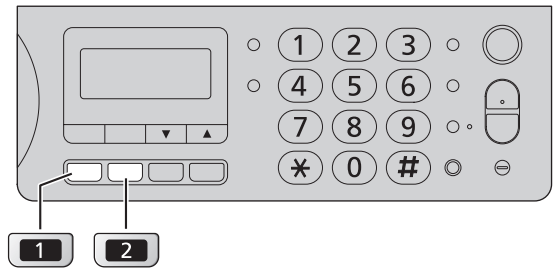

1 Lift the handset.

2 Press the one-touch dialer (**1** or **2**).

Erasing a stored number in the one-touch dialer

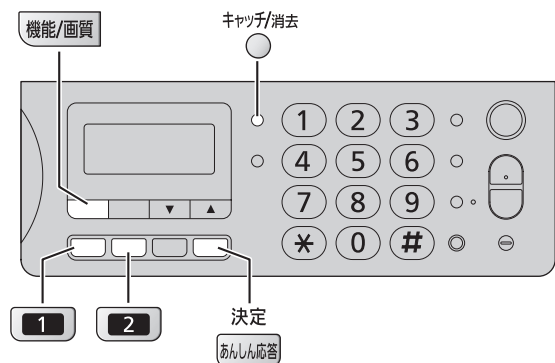

1 Press **機能/画質** (Function/Resolution).

2 Press the one-touch dialer (**1** or **2**).

3 Press **キャッチ/消去** (Flash/Erase).

4 Press **決定** **あんしん応答** (Set).

Automatic dialing on the portable handset (KX-FKN526)

Storing names and telephone numbers in the phonebook

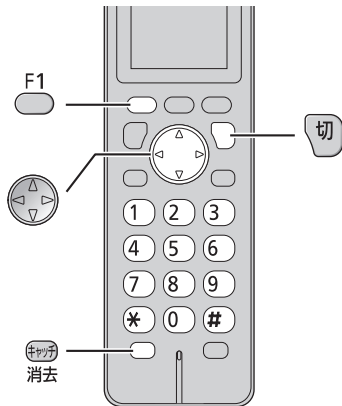

1 Press 電話帳 (Phonebook).

ケンサクハ[▼,▲]オス

2 Press F1.

- “XXX” shows the remaining station numbers you can store.
- You can program up to 150 stations, including 4 pre-programmed stations.

ナマエ? [カナ]
アキ XXXケン

3 Enter the name, up to 12 characters (see the table on page 9 for instructions).

4 Press F1.

5 Enter the telephone number, up to 24 digits.
• To correct a mistake, press (Flash/Erase).

6 Press F1.

7 Enter the group number (① to ⑨).

8 Press F1.
• To program other items, repeat steps 3 to 8.

9 Press (Off) to exit the program.

Making a voice call using the phonebook

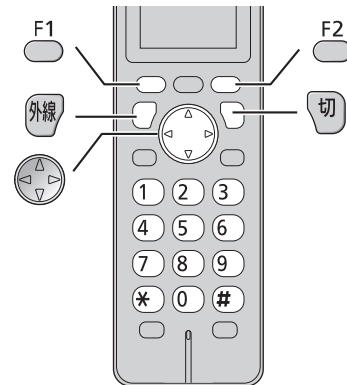

1 Press 電話帳 (Phonebook).

2 Press (Search button) repeatedly until the desired name is displayed.

3 Press (Talk).

Editing a stored name or number in the phonebook

1 Press 電話帳 (Phonebook).

2 Press (Search button) repeatedly until the desired name is displayed.

3 Press F2.

4 Edit the name (see the table on page 9 for instructions).
• If you do not need to edit the name, skip to step 5.

5 Press F1.

6 Enter the correct telephone number.
• If you do not need to edit the telephone number, skip to step 7.

7 Press F1.

8 Edit the group number.
• If you do not need to edit the group number, skip to step 9.

9 Press F1.

10 Press (Off) to exit the program.

Intercom

An intercom is available between the portable handsets or between the main unit and portable handset(s).

Using the main unit:

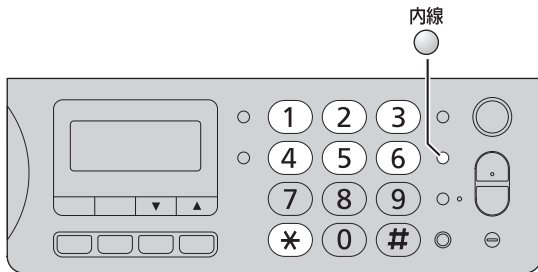

1 ■ For single portable handset users

- ① Lift the handset.

デソバソコウ?

- ② Press ^{内線} (Intercom).

コキヨヒダシチュウ

■ For multiple portable handset users

- ① Lift the handset.

- ② Press ^{内線} (Intercom).

- ③ Call the portable handset(s) in the following ways:

- To call a specific portable handset, press the portable handset number (1 to 6) which you want to call.
- To call all the portable handsets, press *.

2 Start talking.

Example : コキ ナイセンツウ チュウ

3 Replace the handset to end the intercom call.

Using the portable handset (KX-FKN526):

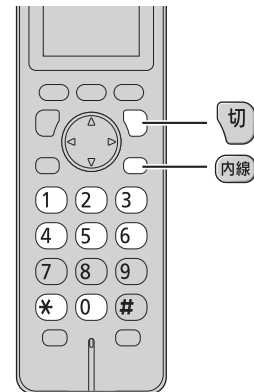

1 ■ For single portable handset users

- Press ^{内線} (Intercom).

■ For multiple portable handset users

- ① Press ^{内線} (Intercom).

- ② Call the main unit and/or portable handset(s) in the following ways:

- To call a specific portable handset, press the portable handset number (1 to 6) which you want to call.
- To call the main unit, press 0.
- To call the main unit and all the portable handsets, press *.

2 Start talking.



ナイセンツウ チュウ

3 Press ^切 (Off) to end the intercom call.

Sending faxes

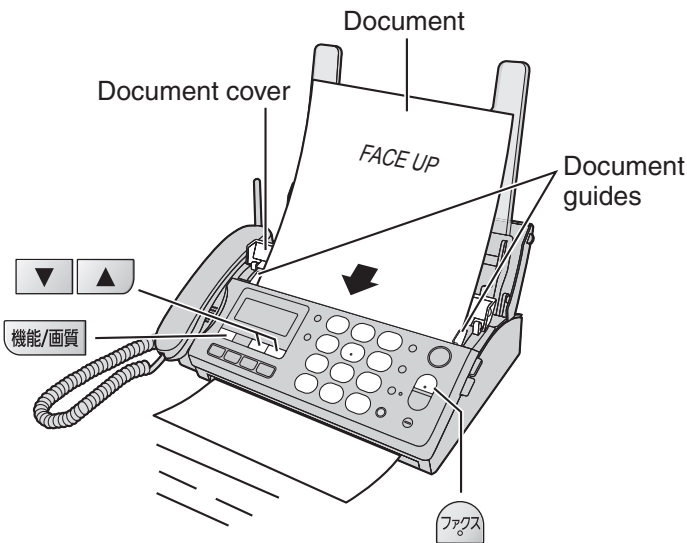
Sending a fax manually





- 1 Open the document cover, and adjust the width of the document guides to the size of the document.
- 2 Insert the document (up to 5 pages) FACE UP until a single beep is heard.
- 3 If necessary, press  (Search button) repeatedly to select the desired resolution while “カ`シツ=” is displayed (see below).
- 4 Press  (Fax).
- 5 Dial the fax number.
- 6 Press  (Fax).
 - The unit will start fax transmission.

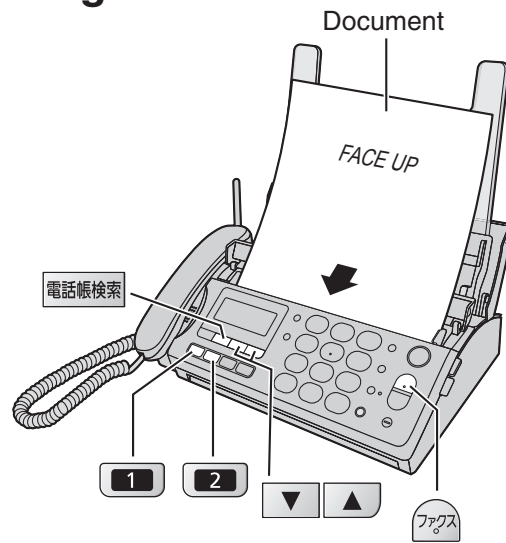

Sending a fax using automatic dialing



Using the phonebook

- 1 Insert the document (up to 5 pages) FACE UP until a single beep is heard.
- 2 Press  (Phonebook).
- 3 Press  (Search button) repeatedly until the desired name is displayed.
- 4 Press  (Fax).
 - The unit will start fax transmission.



Using the one-touch dialer

- 1 Insert the document (up to 5 pages) FACE UP until a single beep is heard.
- 2 Press the one-touch dialer ( or ).
 - The unit will start fax transmission.

To select the resolution

Select the desired resolution according to the type of document, by pressing  repeatedly while “カ`シツ=” is displayed.

To display “カ`シツ=”, press  (Function/Resolution) once or twice.

- | | |
|--|---|
|  | (Standard) for printed or typewritten originals with normal-sized characters. |
|  | (Fine) for originals with minute printing. |
|  | (Photo) for originals containing photographs. |

Receiving faxes

Receiving a fax manually (AUTO ANSWER off)

Using the main unit:

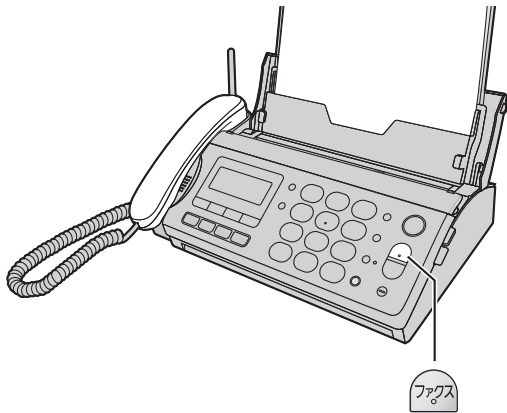



1 When you hear a ring, lift the handset to answer the call.

2 When:
– document reception is required,
– a fax calling tone (slow beep) is heard, or
– no sound is heard,
press  (Fax), then replace the handset.

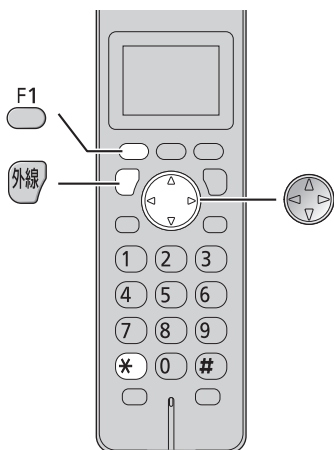

- The unit will start fax reception.

Using the portable handset (KX-FKN526):



1 When you hear a ring, lift the portable handset from the charger, then press  (Talk) to answer the call.

2 When:
– document reception is required,
– a fax calling tone (slow beep) is heard, or
– no sound is heard,
press .



3 Press  (Search button) repeatedly until the “ファクス ジョシ” is displayed, then press .

4 Press .

- The main unit will start fax reception.

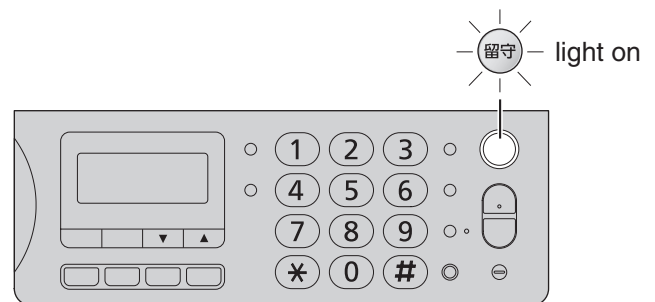
Receiving a fax automatically (AUTO ANSWER on)



1 If the  (Auto answer) light is off, turn it on by pressing .

2 When receiving a call, the unit will receive a fax document or record a voice message automatically depending on the caller's request.

Operating the built-in answering device

Recording your own greeting message

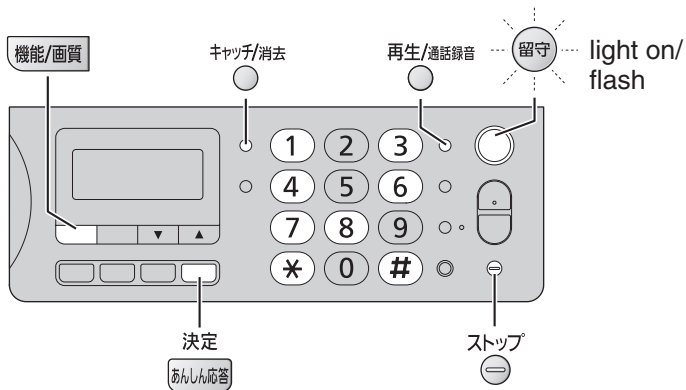

You can record your own greeting message. When receiving a call, it will be played to callers instead of the pre-recorded Japanese greeting message.

- 1 Press **機能/画質** (Function/Resolution).
- 2 Press **# 1 4 7**.
ジ サク オウトウ ロクオン [ケツテイ]オス
- 3 Press **決定 あんしん応答** (Set).
- 4 Lift the handset.
- 5 Press **決定 あんしん応答** (Set) and speak your greeting message after a beep, up to 16 seconds, to the handset.
- 6 Press **ストップ** (Stop) and replace the handset.
 - Your greeting message will be played back automatically.

Erasing your own greeting message

- 1 Press **機能/画質** (Function/Resolution).
- 2 Press **# 1 4 8**.
ジ サク オウトウ ショウキョ [ケツテイ]オス
- 3 Press **決定 あんしん応答** (Set).
- 4 Press *****.
 - The pre-recorded Japanese greeting message will be played when you receive a call.

Activating the answering device

- 1 Turn the **留守** (Auto answer) light on by pressing **留守**.
- 2 When receiving a call, a greeting message will be played and the unit will record a voice message.
 - To record your own greeting message, see left.

Listening to recorded messages

When new messages are recorded, the **留守** (Auto answer) light will flash.

Press **留守** to listen to recorded messages.

After the messages are played back, the following will be displayed.

- To erase the messages, press *****.
- To save the messages, press **#**.

サイセイシタヨクオンショウキョ
スル=* シナイ=#

Listening to all of the recorded messages

Press **再生/通話録音** (Playback) when new messages are not recorded.

- When new messages are recorded, only the new messages will be played back.

After all of the recorded messages are played back, the following will be displayed.

- To erase the messages, press *****.
- To save the messages, press **#**.

スハテ ショウキョシマスカ?
ハイ=* イイ=#

Erasing a specific message

Press **キャッチ/消去** (Flash/Eraser) while listening to the message you want to erase, then press *****.

Erasing all of the recorded messages

- 1 Press **機能/画質** (Function/Resolution).
- 2 Press **# 1 6 3**.
ヨクオン センショウキョ [ケツテイ]オス
- 3 Press **決定 あんしん応答** (Set).
- 4 Press *****.

Operating the built-in answering device

Operating the answering device from a remote location

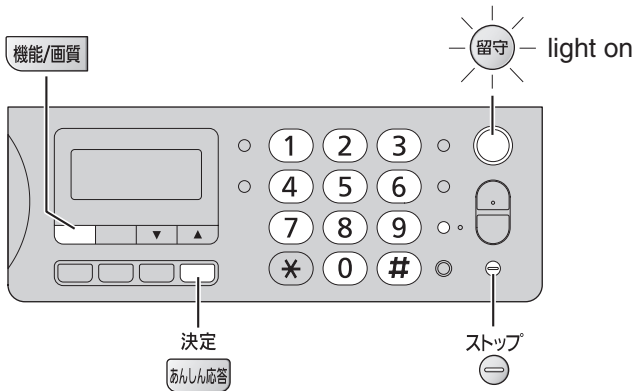

Preparation: Programming the remote operation ID

1. Press **機能/画質** (Function/Resolution).
2. Press **# 0 0 6**.
3. Enter any 4-digit number (remote operation ID) except * or #.

Example :

アソショウ No. = 1234 [4ケタ] → [ケッテイ] オス

4. Press **決定** **あんしん応答** (Set).
5. Press **ストップ** **⊖** (Stop).

Operation: Listening to a recorded message from a remote location

Turn the **留守** (Auto answer) light on before you go out. Remote operations are available only from a touch tone telephone.

1. Call your unit.
2. Enter the remote operation ID during the greeting message.
3. Press **2** or wait 4 seconds.
 - Only the new recorded messages will be played back.
 - To listen to all the recorded messages, press **4**.

Call block

Blocking the incoming calls

Using the main unit:

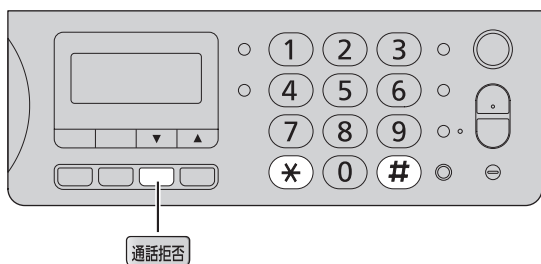

To block a call using a message

While the unit is ringing, press **通話拒否** (Block).

OR

While you are on an incoming call, press **通話拒否** (Block), then press *****.

- The unit announces a message to the caller 2 times, then hangs up automatically. The message is announced in Japanese and means “We’re sorry, but your call cannot be connected.”

To block a call using chimes

- 1 While you are on an incoming call, press **通話拒否** (Block).
- 2 Press **#**.
 - Chimes are heard by the caller.
- 3 Tell the caller that a visitor has come and hang up.

For Number Display service subscribers

If you subscribe to Number Display service, the message heard by the caller will change according to the caller’s situation.

Example :

If the caller requested not to send caller’s information, the message heard by the caller will change to mean
“Your phone number is blocked by service provider.
Please call again with adding ‘186’ to the beginning of the phone number.”

When the following is displayed after pressing

通話拒否 (Block), you can set the unit to block the call from the same telephone number.

■ To block the call, press *****.

メイワク セツテイ シマスカ?
ハイ=* イイエ=#

■ To cancel blocking, press **#**.

● When the following is displayed, press **#** to cancel.

キヨヒ セツテイ シマスカ?
ハイ=* イイエ=#

Using the portable handset (KX-FKN526):

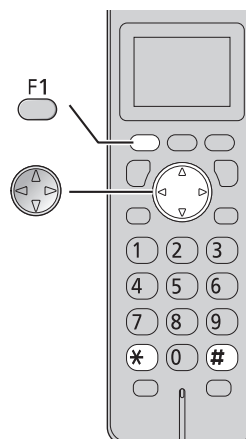

1 While the unit is ringing, press **F1**.

OR

While you are on an incoming call, press **F1**, then press **Search** (Search button) repeatedly until the “ツウワ キヨヒ” is displayed.

2 Press **F1**.

- The unit announces a message to the caller 2 times, then hangs up automatically. The message is announced in Japanese and means “We’re sorry, but your call cannot be connected.”

For Number Display service subscribers

If you subscribe to Number Display service, the message heard by the caller will change according to the caller’s situation.

Example :

If the caller requested not to send caller’s information, the message heard by the caller will change to mean
“Your phone number is blocked by service provider.
Please call again with adding ‘186’ to the beginning of the phone number.”

When the following is displayed after operating step 1 and 2, you can set the unit to block the call from the same telephone number.

■ To block the call, press *****.

メイワク セツテイ?
ハイ=* イイエ=#

■ To cancel blocking, press **#**.

● When the following is displayed, press **#** to cancel.

キヨヒ セツテイ?
ハイ=* イイエ=#

Specifications

KX-PW308DL KX-PW308DW	Main unit	Portable handset (KX-FKN526)	Battery charger
Power supply	AC 100 V (50 Hz/60 Hz)	Ni-MH battery (Part no. KX-FAN51) DC 3.6 V, 650 mAh	AC 100 V (50 Hz/60 Hz)
Power consumption	Transmission: Approx. 10 W Reception: Approx. 13 W Copy: Approx. 16 W Stand by: Approx. 0.7 W (When the F-net service is not in use.) Maximum(*1): Approx. 130 W	/	<ul style="list-style-type: none"> • Charging: Approx. 1.2 W • Stand by: Approx. 0.5 W (When the portable handset is off the charger.)
Dimensions (H x W x D)	Approx. 86 X 296 X 191 mm (without handset, projections) Approx. 265 X 296 X 231 mm (recording paper tray opened, without handset, projections)	Approx. 171 X 44.5 X 33.5 mm	Approx. 34 X 72.5 X 100.5 mm
Mass (Weight)	Approx. 2.4 kg (10 m ink film installed)	Approx. 157 g (battery installed)	Approx. 160 g
Operating environment	5 °C – 35 °C, 45 % – 85 % RH (Relative Humidity)		

KX-PW308DL KX-PW308DW	Main unit
Applicable line	Public Switch Telephone Network (Pulse/Tone), F-Net, NCC Lines
DC resistance	275 Ω
Compatibility	G3 compatible
Document size	A4–A5 (Max. 210 mm in width, Max. 600 mm in length)
Effective scanning size	208 mm (A4)
Effective printing size	202 mm (A4 size plain paper)
Transmission time	Approx. 15 s/page (Original mode) (*2)
Modem speed	9,600 / 7,200 / 4,800 / 2,400 bps; Automatic fallback
Halftone level	64-level
Scanning density	Horizontal: 8 pels/mm Vertical : 7.7 lines/mm (Fine/Photo), 3.85 lines/mm (Standard)
Scanner type	Contact image sensor
Printer type	Thermal transfer printing on plain paper
Data compression system	Modified Huffman (MH), Original mode
Recording paper size	A4: 210 mm x 297 mm (Plain paper)
Answering device	Greeting message: Digital recording system (up to 16 sec) Pre-recording greeting message ICM Recording: Digital recording system (Approx. 12 min. in total) (*3)
Memory capacity	Max. Approx. 50 pages (Only receiving fax etc.) (*4) Max. Approx. 12 min. (Only recording message) (*3)

*1 When copying a 100 % black document.

*2 Transmission speed is based on an A4-size document of 700 characters sent in standard resolution at 9,600 bps. The actual transmission speed depends upon the contents of the page, resolution, telephone line conditions and capability of the other party's machine.

*3 If there is a silent pause, the total recording time will be longer.

*4 The memory capacity is based on an A4-size document of 700 characters sent in standard resolution (8 x 3.85 lines/mm).